

## permaflo<sup>at</sup>® *Specifications*

**15 Year Warranty • Seamless Rotationally-Molded Shell •  
0.150 Nominal Wall Thickness • EPS Foam Filled • Flash Dot®  
ACOE Approved • Tank Tested Buoyancy Ratings +0/-5%**

**COMMERCIAL & RESIDENTIAL 40+ YEARS**

### 2' x 3' SERIES

Part #	Dimensions	Cu.Ft.	Weight	Buoyancy
RP2312	24" x 36" x 12"	6	24	327
RP2316	24" x 36" x 16"	8	28	442

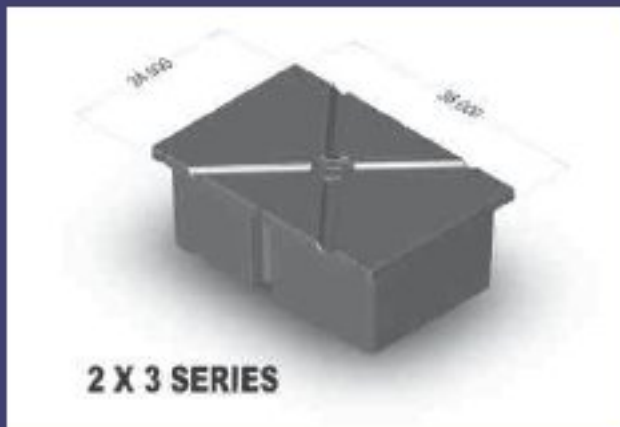

### 2' x 4' SERIES

Part #	Dimensions	Cu.Ft.	Weight	Buoyancy
RP2412	24" x 48" x 12"	8	31	434
RP2416	24" x 48" x 16"	11	37	598
RP2420	24" x 48" x 20"	13	47	719
RP2424	24" x 48" x 24"	16	46	867

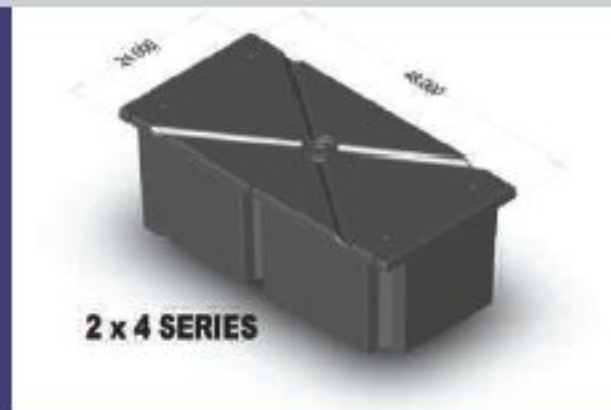

### 3' x 4' SERIES

Part #	Dimensions	Cu.Ft.	Weight	Buoyancy
RP3412	36" x 48" x 12"	12	44	691
RP3416	36" x 48" x 16"	16	51	905
RP3420	36" x 48" x 20"	20	59	1114
RP3424	36" x 48" x 24"	24	67	1346

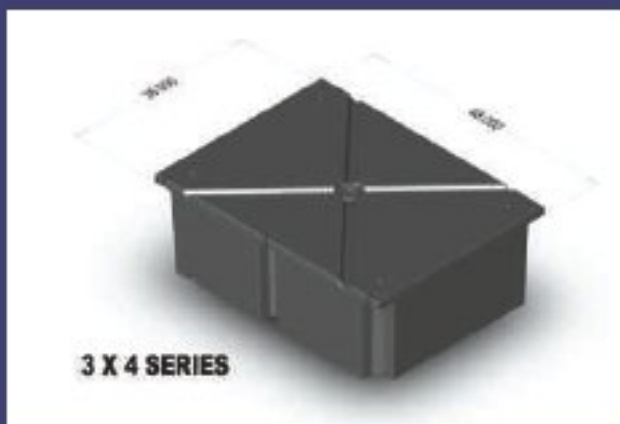

### 3' x 6' SERIES

Part #	Dimensions	Cu.Ft.	Weight	Buoyancy
RP3612	36" x 72" x 12"	18	65	1059
RP3616	36" x 72" x 16"	24	72	1359
RP3620	36" x 72" x 20"	30	84	1727
RP3624	36" x 72" x 24"	36	96	2090
RP3632	36" x 72" x 32"	48	107	2575
RP3,5616	42" x 72" x 16"	28	84	1627

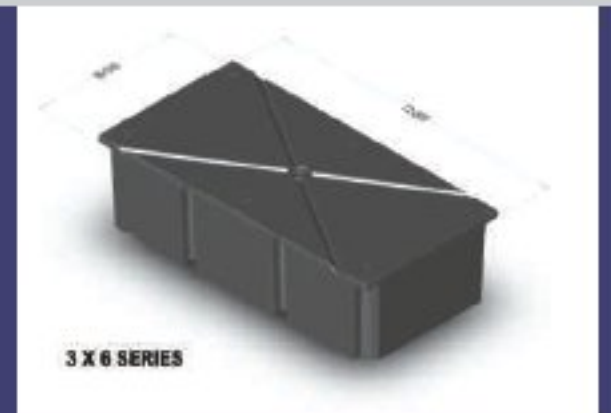

**770-787-6897 [www.rockservices.net](http://www.rockservices.net)**

All weights and dimensions are nominal and subject to manufacturing tolerances.

### 4' x 4' SERIES

Part #	Dimensions	Cu.Ft.	Weight	Buoyancy
RP4412	48" x 48" x 12"	16	53	937
RP4416	48" x 48" x 16"	21	67	1220
RP4420	48" x 48" x 20"	27	77	1520
RP4424	48" x 48" x 24"	32	88	1799



### 4' x 5' SERIES

Part #	Dimensions	Cu.Ft.	Weight	Buoyancy
RP4512	48" x 60" x 12"	20	63	1190
RP4516	48" x 60" x 16"	27	80	1552
RP4520	48" x 60" x 20"	33	87	1900
RP4524	48" x 60" x 24"	40	98	2300



### 4' x 8' SERIES

Part #	Dimensions	Cu.Ft.	Weight	Buoyancy
RP4812	48" x 96" x 12"	32	110	1834
RP4816	48" x 96" x 16"	43	130	2475
RP4820	48" x 96" x 20"	53	144	3076
RP4824	48" x 96" x 24"	64	164	3618
RP4832	48" x 96" x 32"	85	227	4804

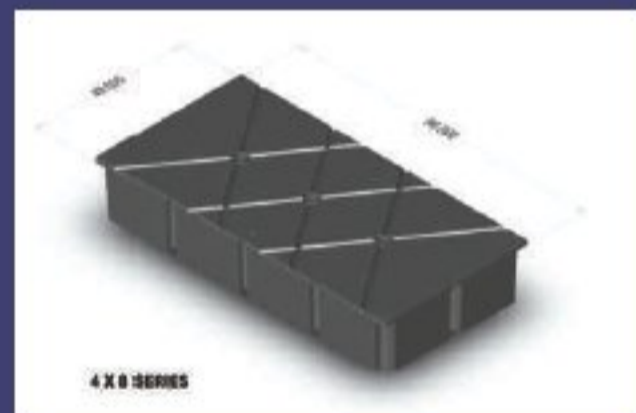

### 4' x 6' SERIES

Part #	Dimensions	Cu.Ft.	Weight	Buoyancy
RP4612	48" x 72" x 12"	24	83	1406
RP4616	48" x 72" x 16"	32	96	1863
RP4620	48" x 72" x 20"	40	112	2280
RP4624	48" x 72" x 24"	48	126	2702
RP4632	48" x 72" x 32"	64	166	3560

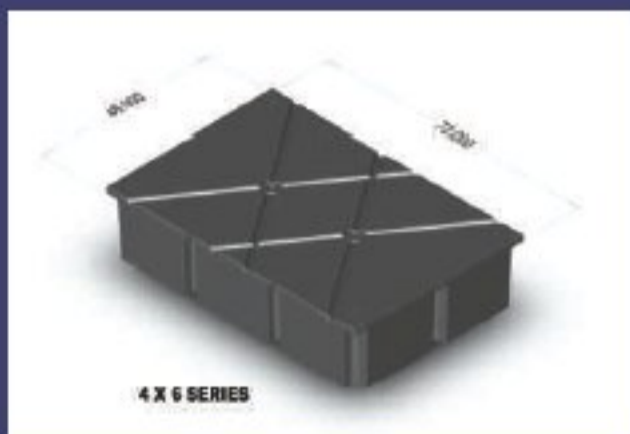

### 3' x 8' SERIES

Part #	Dimensions	Cu.Ft.	Weight	Buoyancy
RP3816	36" x 96" x 16"	32	94	1822
RP3820	36" x 96" x 20"	40	114	2298
RP3824	36" x 96" x 24"	48	127	2687

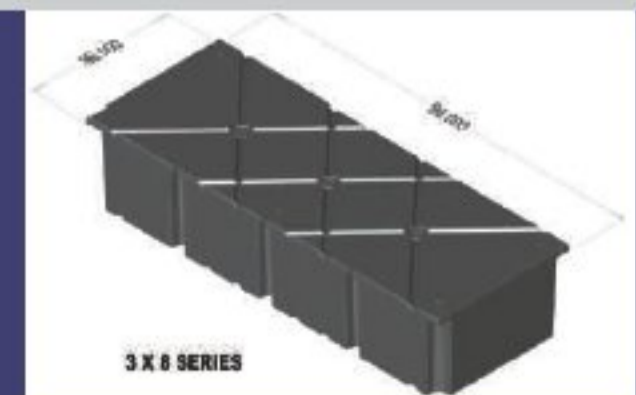

### Additional Float Sizes

RP20728	20" x 72" x 8"	7	32	376
RP348	36" x 48" x 8"	8	32	471

# permaflood<sup>®</sup>

## Specifications

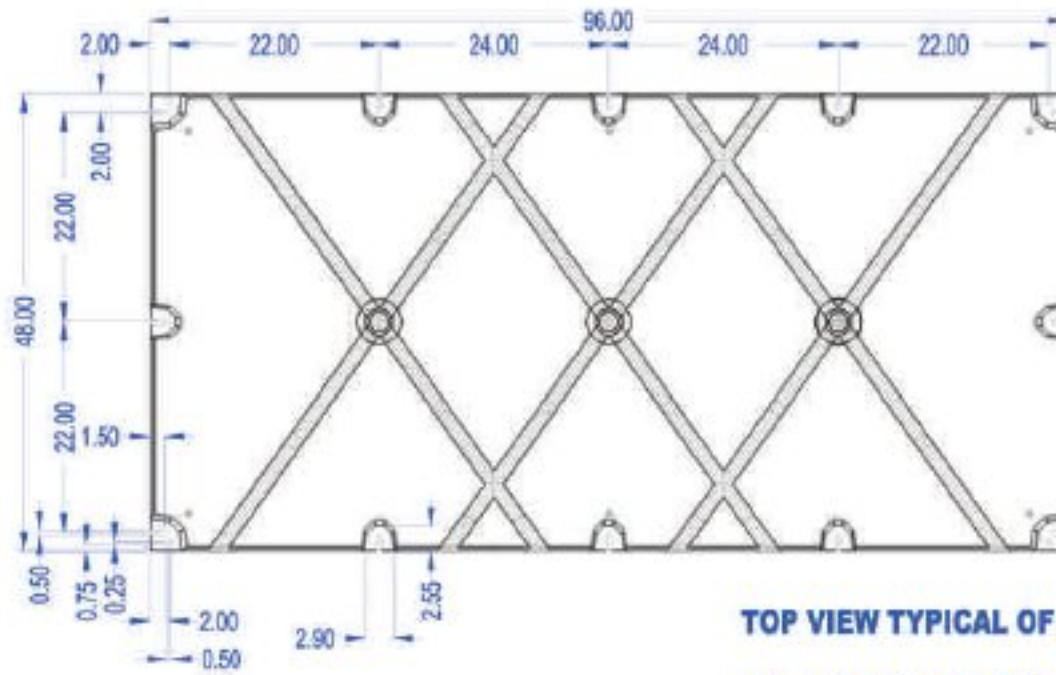

ALL DIMENSIONS ARE NOMINAL

TOP VIEW TYPICAL OF  
ALL 96" X 48" FLOATS  
EXCEPT 32" DEEP



**15 Year Warranty • Seamless Rotationally-Molded Shell •  
0.150 Nominal Wall Thickness • EPS Foam Filled • Flash Dot<sup>®</sup>  
ACOE Approved • Tank Tested Buoyancy Ratings +0/-5%**

770-787-6897 [WWW.ROCKSERVICES.NET](http://WWW.ROCKSERVICES.NET)

The logo for Permafloat, featuring the word "permafloat" in a stylized, blue, lowercase font with a registered trademark symbol.

**15 YEAR WARRANTY**

Permafloat®  
**15 YEAR WARRANTY**  
EFFECTIVE 6/1/2008 NEW STYLE (08) PERMAFLOAT ONLY

Cellofoam North America Inc ("Manufacturer") warrants our encapsulated flotation, to the original owner ("Purchaser"), against cracking, peeling, sloughing, and excessive deterioration from ultraviolet rays while retaining resiliency under normal usage for period of 15 years. The first 11 years are non-prorated. Years 12, 13, 14 and 15 are prorated at 40%, 30%, 20% and 10% of the original purchase price respectively. Defects in workmanship are warranted for a period of 1 year.

Purchaser's remedy is expressly limited to repair or replacement of the defective encapsulated flotation. Determination of a product defect is solely Manufacturer's decision. At Manufacturer's election we will repair, replace or credit Purchaser with an amount not to exceed the original purchase price or portion thereof based on the above scale of prorated coverage. Purchaser shall, within 10 days of discovery, send written notification and the original proof of purchase, to Manufacturer by registered or certified mail of any claim under this warranty. Purchaser will provide Manufacturer with an opportunity to inspect the encapsulated flotation as necessary by returning prepaid to Manufacturer's Conyers, GA plant. In no event shall Manufacturer be liable for any defective encapsulated flotation should examination reveal misuse, negligence, alteration, ice damage, accident, improper installation, overloading, maintenance, repair or acts of God.

Manufacturer makes no representation or warranty of any other kind, expressed or implied with respect to the product(s) sold hereunder as to merchantability, fitness for any purpose, or legality of use in any jurisdiction. Manufacturer shall not be liable for any loss of use, cost, fees or any liability for direct, indirect or consequential damages or delays. No other person, firm or corporation can bind Seller to any warranty other than herein above stated.

The laws of the State of Georgia shall govern this limited warranty.

Rev.9/25/09

The logo for Rock Services, featuring the words "ROCK SERVICES" in a bold, green, sans-serif font. A small, brown, circular object, possibly a rock or a piece of equipment, is positioned between the words "ROCK" and "SERVICES".

**15 Year Warranty • Seamless Rotationally-Molded Shell •  
0.150 Nominal Wall Thickness • EPS Foam Filled • Flash Dot®  
ACOE Approved • Tank Tested Buoyancy Ratings +0/-5%**

770-787-6897 [WWW.ROCKSERVICES.NET](http://WWW.ROCKSERVICES.NET)